

Pressure Relief Valve

Model FP 730-UF

The BERMAD Model FP 730-UF pilot operated relief valve prevents overpressure, maintaining a constant preset system pressure regardless of fluctuating conditions. It is UL-Listed (up to 350 psi) and FM-Approved in accordance with NFPA-20. The valve offers reliable performance when installed in: Refineries, petrochemical complexes, tank farms, high-rise buildings, aviation and airports, marine and on-shore installations.

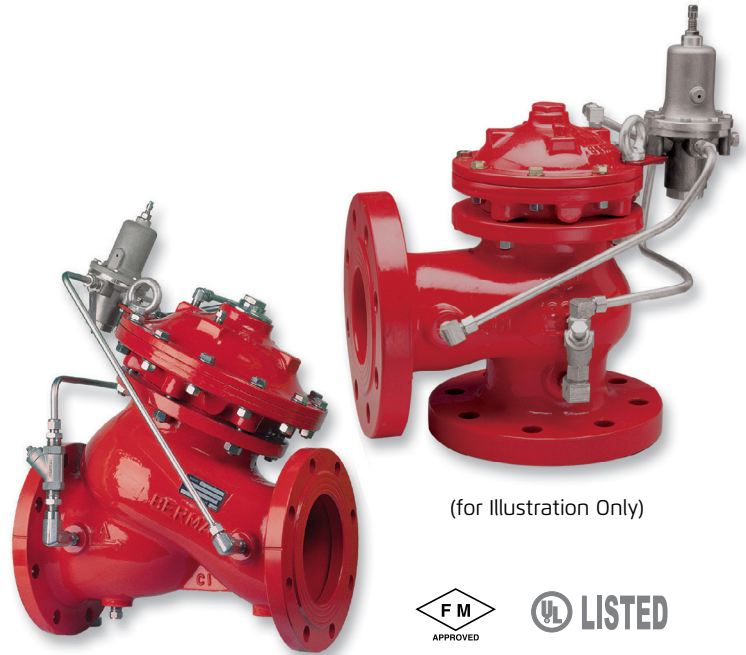

Features and Benefits

- **Hydraulically powered valve seal design**
 - Reliable drip tight sealing
 - Eliminates jamming problems
- **Hydro-efficient body design**
 - Wide operating range
 - Unobstructed straight through flow path
- **Double-chambered unitized actuator**
 - Easy, inline inspection ensures minimal down time
 - Quick and smooth valve action

Optional Features

- **Large control filter** (code: F)
- **Seawater service construction**

Note: Optional features can be mixed and matched. Consult your local BERMAD representative for full details.

Typical Applications



Pressure relief for individual diesel fire pumps



Pump station pressure relief

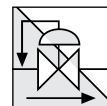

Centralized thermal pressure relief

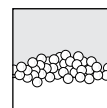

Foam recirculation; maintains required foam pressure



Zone safety relief

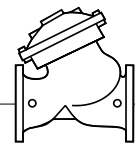

Operation

The BERMAD Model FP 730-UF remains closed as long as the sensed inlet pressure is lower than the adjustable set point. When the Pressure Relief Pilot [1] senses inlet pressure [2] that is higher than the pilot setting, it opens releasing water pressure from the control chamber [3] causing the main valve to modulate open, relieving excess pressure to either a reservoir or sump, preventing system overpressure.

The Pressure Relief Pilot is equipped with an adjusting screw [4] to preset the desired inlet pressure and an integral adjustable needle valve [5] to control the main valve closing speed. The valve's unique design and quick reaction to system demand keeps pressure loss at a minimum. To further enhance reliability the control system is equipped with a control strainer [6].

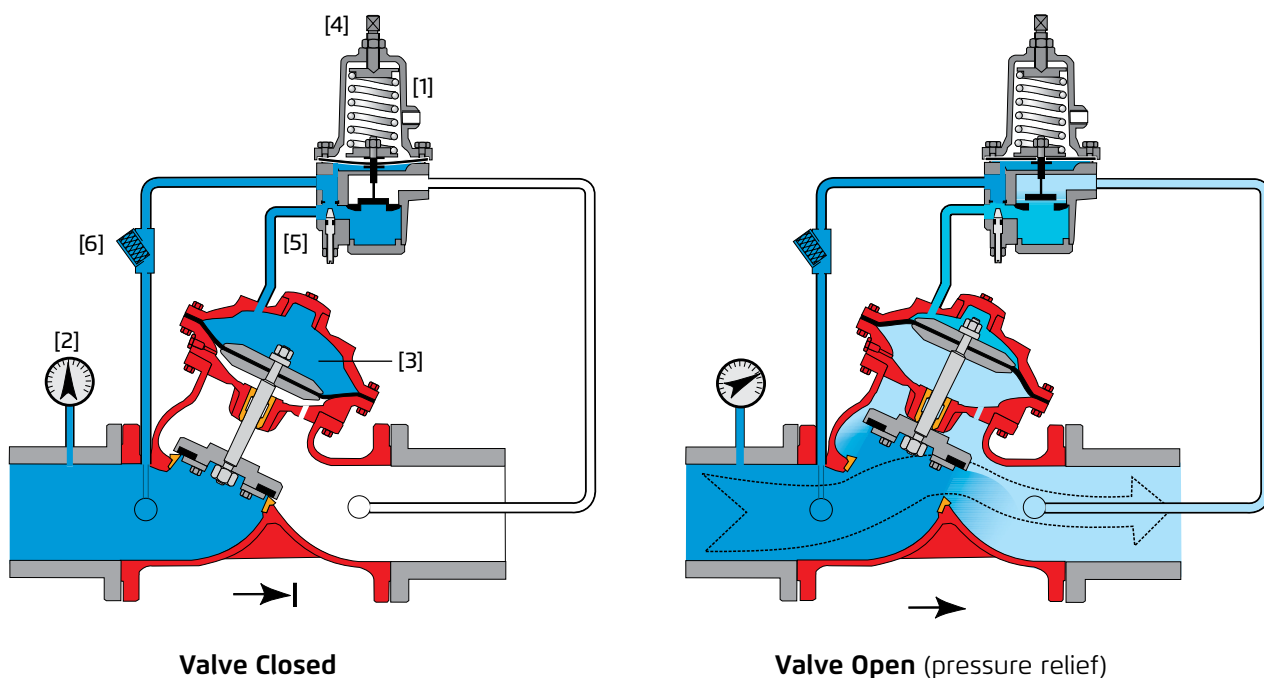

Engineer Specifications

The Pressure Relief Valve shall be UL-Listed, FM-Approved and hydraulic pilot controlled. The main valve shall be an angle or "Y" pattern. All necessary inspection and servicing of the main valve shall be possible in-line.

Valve actuation shall be accomplished by a double chambered actuator, which shall include a stainless steel stem and a flat seal disk creating a drip tight seal.

The valve seat shall be made of stainless steel and have an **unobstructed flow path**, with no stem guide or **supporting ribs**.

The pilot system shall be field adjustable, with adjustable valve closing speed, integrated to the pilot valve, hydraulically tested and supplied as an assembly consisting of:

- Relief pilot valve UL-Listed and FM-Approved as part of the assembly with built-in, internal needle valve
- "Y" strainer

The control trim shall be supplied as an assembly, pre-assembled and hydraulically tested at an ISO 9000 and 9001 certified factory.

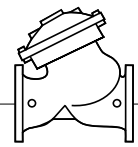

Typical Installations

Installation with
Angle pressure
relief valve

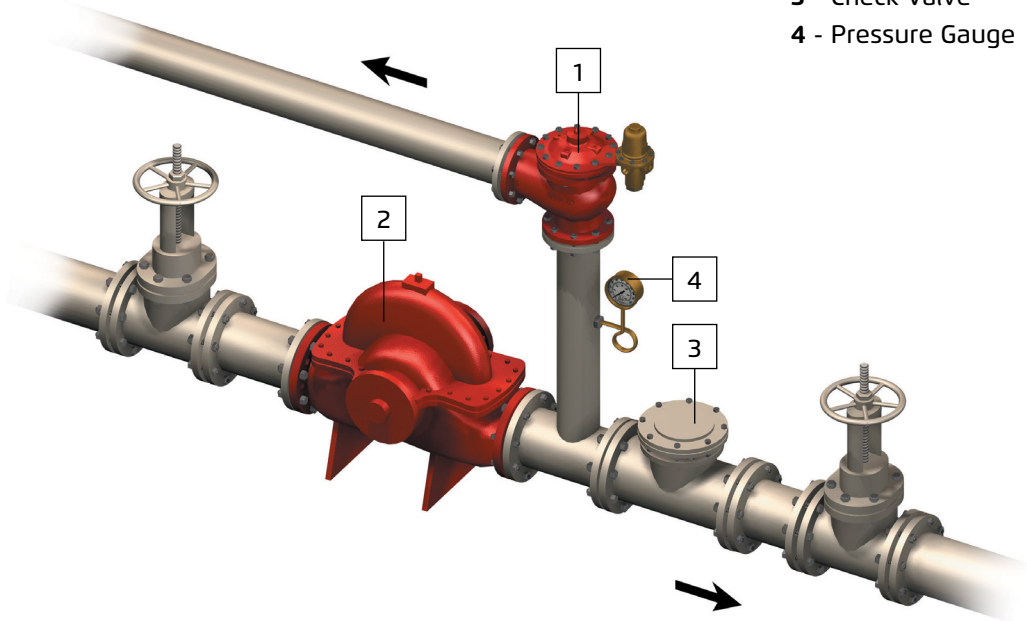

Installation with
"Y" Pattern
relief valve

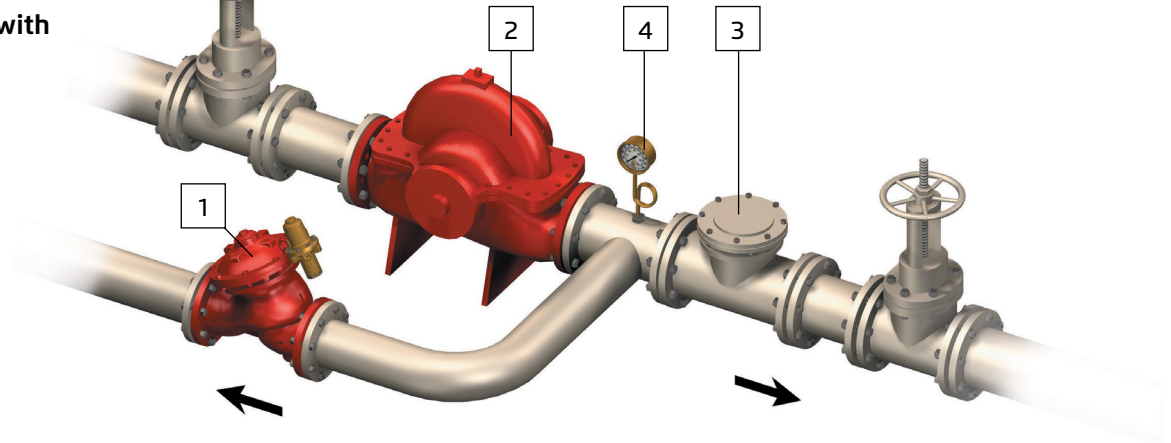

For illustration only

System Components

- 1 - BERMAD Model FP 730-UF
- 2 - Fire Pump
- 3 - Check Valve
- 4 - Pressure Gauge

Installation Considerations

- Valve size should be no less than NFPA-20 requirements
- Provide adequate clearance around valve for maintenance, ensuring that the actuator can be easily removed
- Design installation with the valve cover up for best performance
- Ensure that before the valve is installed, instructions are given to flush the pipeline at full flow

UL Listed

The BERMAD Model FP 730-UF is UL-Listed and FM-Approved when installed as a unit

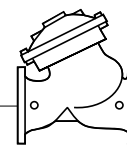

Technical Data

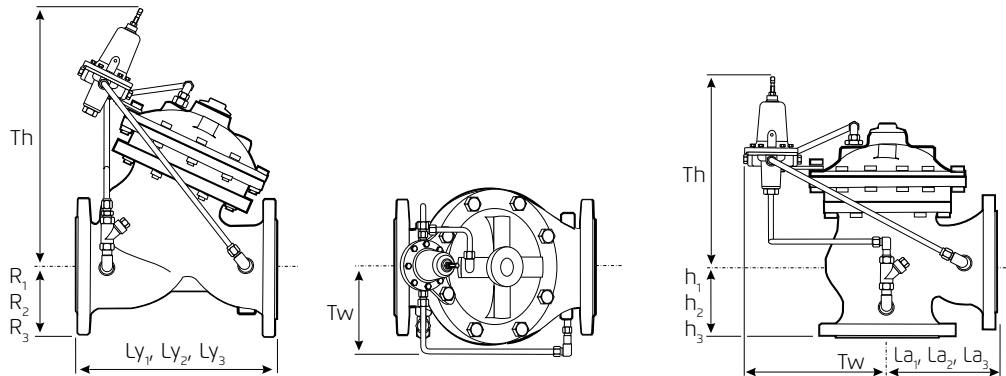

Size	1½"		2"		2½"		3"		4"		6"		8"		10"		12"		14"		16"		
	mm	inch	mm	inch	mm	inch	mm	inch	mm	inch	mm	inch	mm	inch	mm	inch	mm	inch	mm	inch	mm	inch	
Dimensions	Ly ₁ ⁽¹⁾	205	8 ¹ / ₁₆	205	8 ¹ / ₁₆	210	8 ³ / ₄	250	9 ⁷ / ₈	320	12 ⁵ / ₈	415	16 ³ / ₈	500	19 ¹ / ₁₆	605	23 ¹³ / ₁₆	725	28 ⁹ / ₁₆	733	28 ⁷ / ₈	990	39
	Ly ₂ ⁽²⁾	155	6 ¹ / ₈	155	6 ¹ / ₈	212	8 ³ / ₈	250	9 ¹³ / ₁₆	N/A	N/A	N/A	N/A	N/A	N/A	N/A	N/A	N/A	N/A	N/A	N/A	N/A	N/A
	Ly ₃ ⁽³⁾	210	8 ³ / ₄	210	8 ³ / ₄	212	8 ³ / ₈	264	10 ⁷ / ₁₆	335	13 ¹ / ₄	433	17 ¹ / ₁₆	524	20 ⁵ / ₈	637	25	762	30	767	30 ³ / ₁₆	1,024	40 ³ / ₄
	La ₁ ⁽¹⁾	121	4 ³ / ₄	121	4 ³ / ₄	140	5 ¹ / ₂	152	6	190	7 ¹ / ₂	225	8 ⁷ / ₈	265	10 ⁷ / ₁₆	320	12 ⁵ / ₈	396	15 ⁹ / ₁₆	400	15 ³ / ₄	450	17 ³ / ₄
	La ₂ ⁽²⁾	120	4 ³ / ₄	120	4 ³ / ₄	140	5 ¹ / ₂	159	6 ¹ / ₄	N/A	N/A	N/A	N/A	N/A	N/A	N/A	N/A	N/A	N/A	N/A	N/A	N/A	N/A
	La ₃ ⁽³⁾	127	5	127	5	149	5 ⁷ / ₈	159	6 ¹ / ₄	200	7 ⁷ / ₈	234	9 ³ / ₁₆	277	10 ⁷ / ₈	336	13 ¹ / ₄	415	16 ⁵ / ₁₆	419	16 ¹ / ₂	467	18 ³ / ₈
	h ₁ ⁽¹⁾	82	3 ¹ / ₄	82	3 ¹ / ₄	102	4	102	4	127	5	152	6	203	8	219	8 ⁵ / ₈	275	10 ¹³ / ₁₆	275	10 ¹³ / ₁₆	369	14 ¹ / ₂
	h ₂ ⁽²⁾	82	3 ¹ / ₄	82	3 ¹ / ₄	102	4	114	4 ¹ / ₂	N/A	N/A	N/A	N/A	N/A	N/A	N/A	N/A	N/A	N/A	N/A	N/A	N/A	N/A
	h ₃ ⁽³⁾	89	3 ¹ / ₂	89	3 ¹ / ₂	109	4 ⁵ / ₁₆	108	4 ¹ / ₄	135	5 ⁵ / ₁₆	165	6 ¹ / ₂	216	8 ¹ / ₂	235	9 ¹ / ₄	294	11 ¹ / ₂	294	11 ¹ / ₂	386	5 ³ / ₁₆
	R ₁ ⁽¹⁾	75	2 ¹⁵ / ₁₆	83	3 ¹ / ₄	93	3 ⁵ / ₈	100	3 ¹⁵ / ₁₆	114	4 ¹ / ₂	140	5 ¹ / ₂	171	6 ³ / ₄	203	8	241	9 ¹ / ₂	267	10 ¹ / ₂	298	11 ³ / ₄
	R ₂ ⁽²⁾	40	1 ⁹ / ₁₆	40	1 ⁹ / ₁₆	48	1 ⁷ / ₈	55	21	N/A	N/A	N/A	N/A	N/A	N/A	N/A	N/A	N/A	N/A	N/A	N/A	N/A	N/A
	R ₃ ⁽³⁾	78	3 ¹ / ₁₆	83	3 ¹ / ₄	95	3 ³ / ₄	108	4 ¹ / ₄	127	5	159	6 ¹ / ₄	191	7 ¹ / ₂	222	8 ³ / ₄	260	10 ¹ / ₄	292	11 ¹ / ₂	324	12 ³ / ₄
	Tw	191	7 ¹ / ₂	191	7 ¹ / ₂	191	7 ¹ / ₂	207	8 ¹ / ₁₆	242	9 ¹ / ₂	290	11 ⁷ / ₁₆	325	12 ¹³ / ₁₆	370	14 ⁹ / ₁₆	515	20 ¹ / ₄	525	20 ¹¹ / ₁₆	610	24
	Th	312	12 ⁵ / ₁₆	312	12 ⁵ / ₁₆	312	12 ⁵ / ₁₆	364	14 ¹ / ₂	405	15 ¹⁵ / ₁₆	505	20	566	22 ⁵ / ₁₆	639	25 ³ / ₁₆	449	17 ¹¹ / ₁₆	449	17 ¹¹ / ₁₆	541	21 ⁵ / ₁₆

Notes:

1. Ly₁ for ANSI#150, ISO PN16 & Grooved ends (see available sizes below)
2. La₁ & h₁ for Angle body, ANSI#150 and ISO PN16.
3. Ly₂, La₂ & h₂ for threaded female, NPT or BSP.
4. Ly₃, La₃ & h₃ for flanged ANSI #300 and ISO PN25.
5. Data is for maximum envelope dimensions, component positioning may vary.
6. Provide adequate space around valve for maintenance.

Connection Standard

- Flanged: ANSI B16.42 (Ductile Iron), B16.5 (Steel & Stainless Steel), B16.24 (Bronze), ISO PN16
- Threaded: NPT or ISO-7-Rp 2, 2½ & 3"
- Grooved: ANSI/AWWA C606 for 2, 3, 4, 6 & 8"

Water Temperature

- 0.5 - 80°C (33 - 180°F)

Manufacturers Standard Materials

Main valve body and cover

- Ductile Iron ASTM A-536

Main valve internals

- Stainless Steel, Bronze and coated Steel

Control Trim System

- Brass control components/accessories
- Forged Brass fittings & Copper tubing

Elastomers

- NBR (Buna-N)

Coating

- Electrostatic Powder Coating Polyester, Red (RAL 3002)

Sizes ("Y" & Angle)

- Available Y: 1½ - 20", Angle: 1½ - 18"
- UL Listed and FM approved: 2, 2½, 3, 4, 6 & 8"

Optional Materials

Main Valve Body/Internals

- Carbon Steel ASTM A-216-WCB
- Stainless Steel 316
- Ni-Al-Bronze ASTM B-148
- Titanium
- Duplex
- Hastalloy

Control Trim

- Stainless Steel 316
- Monel® and Al-Bronze
- Hastalloy C-276

Coating

- High Build Epoxy Fusion-Bonded with UV Protection, Anti-Corrosion

Pressure Rating

- UL Listed - 2 to 6": 350 psi (24 bar) 8": 175 psi (12 bar)
- ANSI#150 235 psi/16 bar (code A5)
- ANSI#300 350/24 bar (code A3)
- ISO 16 235 psi/16 bar (code 16)
- ISO 25 350/24 bar (code 25)
- Grooved 235psi/PN16, ANSI C606 (code V1)
- Grooved 365psi/PN25, ANSI C606 (code V2)
- Threaded 235psi/PN16, ISO-7-Rp (code BP)
- Threaded 365psi/PN25, ISO-7-Rp (code BH)
- Threaded 235psi/PN16, NPT (code NP)
- Threaded 365psi/PN25, NPT (code NH)

Pressure Settings Range

- Class #150: 30 - 235 psi (2 - 16 bar)
- Class #300: 100 - 350 psi (7 - 24 bar)

Approvals

- UL Listed - Fire Pump Relief Valve (QXZQ)
- FM Approved - Water Relief Valve and Fire Pump Relief Valve
- ISO 9001 QA certified
- ABS - Type Approved
- Lloyd's Register - Type Approved

